

## HG SERIES REED RELAYS

HGRM • HGR2M • HGR2MT • HGSR • HGSM • HGJM • HGJ2MT  
 HGWR • HGWM • HGW2MT • HG • HGM



### DESCRIPTION

The HGRM is available in single side and bistable adjustments for all types of industrial as well as classic telecom and datacom applications. A potted relay body with a metal can guarantees a double sealing technology, standard in all relays. The powerful switching rating (100W-500V-2A) and the input-output 1kVAC isolation make it an all-around product. Form-C/break-before-make and Form-D/make-before-break are available.

The HGJM and HGWM relay families are designed for industrial use, especially for process control and data loggers. Both families feature fast operating speeds, Common Open Time and combine very low noise and thermal EMF. They are ideal relays for flying capacitance type as well as for direct reading process controls. These relays offer a magnetic and an electro-static shield for minimizing all external influences. A life of billions of operations, low & stable contact resistance and a 1kVAC input-output isolation make these families the highest industrial standard of their kind. No other relay offers so much in such a small package.

### FEATURES

- Stable contact resistance over life
- 100W - 500V - 2A switching power
- Common Open Time (some series)
- Zero load switching
- High insulation resistance
- Long life >1 x 10<sup>9</sup>
- Single side and bistable adjustments
- Bounce-free operation
- Low noise and thermal emf (HGWM & HGJM)
- Form-C & D
- Load handling capability from signal level to 100VA (500 VDC or 2A maximum load switching capability, HGSM & HGSR)
- Can switch up to 80Hz (HGSM, HGSR)
- Octal plug in high performance reed relay multi-pole 1 & 2 Form-D
- 250 VA switching capability
- Operating rates up to 200Hz
- Magnetically shielded

### APPROVALS

- UL recognition
- CSA certification (HGRM)
- FCC68 compatible (HGRM & HGJM)

### APPLICATIONS

- Process control
- Data loggers
- Traffic control systems
- Signalling
- Industrial
- PLCs
- Metering systems
- Telecom (HGRM)

### RATINGS (@ 25° C)

Parameter	Min	Typ	Max	Unit
Switching Voltage			500	Volts
Switching Current				
HGJM/HGWM/HGWR			2	Amps
HGRM/HGSR/HGSM			2	Amps
HGM/HG			5	Amps
Carry Current				
HGJM/HGWM/HGWR			5	Amps
HGRM/HGSR/HGSM			5	Amps
HGM/HG			10	Amps
Switching Frequency				
HGJM/HGWM/HGWR			200	Hz
HGRM/HGSR/HGSM			200	Hz
HGM/HG			80	Hz
Contact Resistance			30	mΩ

(See detailed specifications for more information.)

## HG SERIES REED RELAYS

**HGRM • HGR2M • HGR2MT • HGSR • HGSM • HGJM • HGJ2MT  
HGWR • HGWM • HGW2MT • HG • HGM**

### SPECIFICATIONS

PARAMETER	CONDITIONS	SYMBOL	HGRM HGR2M HGR2MT			HGSR			HGSM			UNITS
			MIN	TYP	MAX	MIN	TYP	MAX	MIN	TYP	MAX	
All parameters are at 25°C unless otherwise stated.												
			1 & 2-Form-C & D			1-Form-C & D			1-Form-C & D			
<b>Contact Ratings</b>												
Switching Voltage	Max DC/PeakAC Resistive	VL	-	-	500	-	-	500	-	-	500	Volts
Switching Current	Max DC/PeakAC Resistive	IL	-	-	2	-	-	2	-	-	2	Amps
Carry Current	Max DC/PeakAC Resistive	Ic	-	-	5	-	-	5	-	-	5	Amps
Contact Rating	Max DC/PeakAC Resistive	-	-	-	100	-	-	100	-	-	100	Watts
Life Expectancy	Signal Level 1.0V 10mA	-	1000	2000	-	1000	2000	-	1000	2000	-	x10 <sup>6</sup> Ops
Static Contact Resistance	50mV, 10mA at 100Hz, 1.5 msec.	CR	-	-	30	-	-	30	-	-	30	mΩ
Contact Material		-	-	Hg	-	-	Hg	-	-	Hg	-	-
Mercury Content		-	-	0.32	-	-	0.32	-	-	0.32	-	grams
<b>Relay Specifications</b>												
Insulation Resistance	Between all isolated pins at 100V, 25°C, 40% RH	IR	10 <sup>8</sup>	-	-	10 <sup>8</sup>	-	-	10 <sup>8</sup>	-	-	Ω
Capacitance <sup>(1)</sup>	Across Open Contacts	-	-	-	3	-	-	-	-	-	4	pF
	Open Contact to Coil	-	-	-	9	-	-	-	-	-	4	pF
Dielectric Strength <sup>(2)</sup>	Between Contacts	-	1400	-	-	1400	-	-	1400	-	-	VDC/PeakAC
	Contacts to Coil	I/O	1400	-	-	1400	-	-	1400	-	-	VDC/PeakAC
Operate Time, no bounce	At Nominal Coil Voltage 10Hz Square Wave	TOP	-	-	2.5	-	-	2.5	-	-	2.5	ms
Transfer Time (Form C)		-	50	-	500	50	-	500	50	-	500	μs
Bridging Time (Form D)		-	-	-	500	-	-	500	-	-	500	μs
Release Time	Zener-Diode Suppression	TREL	-	-	2.5	-	-	2.5	-	-	3.0	ms
<b>Environmental Ratings</b>												
Storage Temperature		TA	-40	-	+105	-40	-	+105	-40	-	+105	°C
Operating Temperature		TO	-38	-	+85	-38	-	+85	-38	-	+85	°C
Soldering Temperature	Applied to pins, 10 sec. max.	-	-	-	+260	-	-	+260	-	-	+260	°C
Vibration Resistance (Survival)	10Hz - 500Hz	G	-	-	5	-	-	5	-	-	5	Gs
Shock Resistance (Survival)	11±1ms, 1/2 Sine Wave	S	-	-	30	-	-	30	-	-	30	Gs
Weight		-	-	15	-	-	13	-	-	57	-	grams

(1) No Shield  
(2) 2800VDC available

## HG SERIES REED RELAYS

HGRM • HGR2M • HGR2MT • HGSR • HGSM • HGJM • HGJ2MT  
 HGWR • HGWM • HGW2MT • HG • HGM

### SPECIFICATIONS

All parameters are at 25°C unless otherwise stated.

PARAMETER	CONDITIONS	SYMBOL	HGJM HGJ2MT 1 & 2-Form-C			HGWR 1-Form-C			HGSM HGW2MT 1 & 2-Form-C			UNITS
			MIN	TYP	MAX	MIN	TYP	MAX	MIN	TYP	MAX	
<b>Contact Ratings</b>												
Switching Voltage	Max DC/PeakAC Resistive	VL	-	-	500	-	-	500	-	-	500	Volts
Switching Current	Max DC/PeakAC Resistive	IL	-	-	2	-	-	2	-	-	2	Amps
Carry Current	Max DC/PeakAC Resistive	Ic	-	-	5	-	-	5	-	-	5	Amps
Contact Rating	Max DC/PeakAC Resistive	-	-	-	100	-	-	100	-	-	100	Watts
Life Expectancy	Signal Level 1.0V 10mA	-	1000	2000	-	1000	2000	-	1000	2000	-	x10 <sup>6</sup> Op
Static Contact Resistance	50mV, 10mA at 100Hz,	CR	-	-	30	-	-	30	-	-	30	mΩ
Contact Material		-	-	Hg	-	-	Hg	-	-	Hg	-	-
Mercury Content		-	-	0.32	-	-	0.32	-	-	0.32	-	grams
<b>Relay Specifications</b>												
Insulation Resistance	Between all isolated pins at 100V, 25°C, 40% RH	IR	10 <sup>9</sup>	-	-	10 <sup>9</sup>	-	-	10 <sup>9</sup>	-	-	Ω
Capacitance <sup>(1)</sup>	Across Open Contacts	-	-	-	4	-	-	4	-	-	5	pF
	Open Contact to Coil	-	-	-	10	-	-	7.5	-	-	12	pF
Dielectric Strength <sup>(2)</sup>	Between Contacts	-	1400	-	-	1400	-	-	1400	-	-	VDC/PeakAC
	Contacts to Coil	I/O	1400	-	-	1400	-	-	1400	-	-	VDC/PeakAC
Operate Time, no bounce	At Nominal Coil Voltage 10Hz Square Wave	Top	-	-	1.25	-	-	2	-	-	1.25	ms
Transfer Time (Form C)		-	50	-	500	50	-	500	50	-	500	μs
Release Time	Zener-Diode Suppression	TREL	-	-	1.25	-	-	2	-	-	1.25	ms
<b>Environmental Ratings</b>												
Storage Temperature		TA	-40	-	+105	-40	-	+105	-40	-	+105	°C
Operating Temperature		To	-38	-	+85	-38	-	+85	-38	-	+85	°C
Soldering Temperature	Applied to pins, 10 sec. max.	-	-	-	+260	-	-	+260	-	-	+260	°C
Vibration Resistance (Survival)	10Hz - 500Hz	G	-	-	5	-	-	5	-	-	5	Gs
Shock Resistance (Survival)	11±1ms, 1/2 Sine Wave	S	-	-	30	-	-	30	-	-	30	Gs
Weight		-	-	12.5	-	-	10.6	-	-	9.2	-	grams

(1) No Shield

(2) 2800VDC available

## HG SERIES REED RELAYS

HGRM • HGR2M • HGR2MT • HGSR • HGSM • HGJM • HGJ2MT  
HGWR • HGWM • HGW2MT • HG • HGM

### SPECIFICATIONS

All parameters are at 25°C unless otherwise stated.

PARAMETER	CONDITIONS	SYMBOL	HG			HGM			UNITS
			MIN	TYP	MAX	MIN	TYP	MAX	
<b>Contact Ratings</b>									
Switching Voltage	Max DC/PeakAC Resistive	VL	-	-	500	-	-	500	Volts
Switching Current	Max DC/PeakAC Resistive	IL	-	-	5	-	-	5	Amps
Carry Current	Max DC/PeakAC Resistive	Ic	-	-	10	-	-	10	Amps
Contact Rating	Max DC/PeakAC Resistive		-	-	250	-	-	250	Watts
Life Expectancy	Signal Level 1.0V 10mA	-	1000	2000	-	1000	2000	-	x10 <sup>6</sup> Ops
Static Contact Resistance	50mV, 10mA	CR	-	-	30	-	-	30	mΩ
Contact Material		-	-	Hg	-	-	Hg	-	-
Mercury Content		-	-	3	-	-	3	-	grams
<b>Relay Specifications</b>									
Insulation Resistance	Between all isolated pins at 100V, 25°C, 40% RH	IR	107	-	-	107	-	-	Ω
Capacitance <sup>(1)</sup>	Across Open Contacts	-	-	-	8.5	-	-	5	pF
	Open Contact to Coil	-	-	-	17.5	-	-	5.5	pF
Dielectric Strength <sup>(2)</sup>	Between Contacts	-	1400	-	-	1400	-	-	VDC/PeakAC
	Contacts to Coil	I/O	1400	-	-	1400	-	-	VDC/PeakAC
Operate Time, no bounce	At Nominal Coil Voltage 10Hz Square Wave	TOP	-	-	7	-	-	5	ms
Transfer Time (Form C)		-	-	N/A	-	-	N/A	-	μs
Bridging Time (Form D)		-	-	-	1000	-	-	1000	μs
Release Time	No Diode Suppression	TREL	-	-	4	-	-	4.7	ms
<b>Environmental Ratings</b>									
Storage Temperature		TA	-65	-	+105	-65	-	+105	°C
Operating Temperature		To	-38	-	+105	-38	-	+105	°C
Soldering Temperature	Applied to pins, 10 sec. max.		-	-	-	-	-	-	°C
Vibration Resistance (Survival)	10Hz - 500Hz	G	-	-	10	-	-	10	Gs
Shock Resistance (Survival)	11±1ms, 1/2 Sine Wave	S	-	-	30	-	-	30	Gs
Weight		-	-	115	-	-	86	-	grams

(1) No Shield

(2) 2800VDC available

## HG SERIES REED RELAYS

HGRM • HGR2M • HGR2MT • HGSR • HGSM • HGJM • HGJ2MT  
 HGWR • HGWM • HGW2MT • HG • HGM

### COIL SPECIFICATIONS

Units Conditions Part #	Contact Form	Coil Voltage			Coil Resistance			Operate Voltage		
		Volts			Ω			Volts		
		Min	Typ	Max	Min	Typ	Max	Min	Typ	Max
HGJM 51111 K00	1-Form-C/SSS		5	15	112.5	125	137.5			2.9
HGJM 51111 P00	1-Form-C/SSS		12	35	616.5	685	753.5			7.1
HGJM 51111 T00	1-Form-C/SSS		24	68	2385	2650	2915			14
HGJM 51111 W00	1-Form-C/SSS		48	125	8865	9850	10835			29
HGJ2MT 54211 G00	2-Form-C/SSS		5	14	49.5	55	60.5			2.6
HGJ2MT 54211 L00	2-Form-C/SSS		12	36	333	370	407			6.7
HGJ2MT 54211 P00	2-Form-C/SSS		24	69	1233	1370	1507			13
HGWR 56211 H00	1-Form-C/SSS		3	5	23.4	26	28.6			1.2
HGWR 56211 L00	1-Form-C/SSS		6	12	117	130	143			2.9
HGWR 56211 P00	1-Form-C/SSS		12	20	360	400	440			4.9
HGWR 56211 T00	1-Form-C/SSS		24	38	1215	1350	1485			10.1
HGWR 56211 W00	1-Form-C/SSS		48	70	4050	4500	4950			21.8
HGWR 58211 T00	1-Form-C/BS		1.5	5	25.2	28	30.8			±0.7
HGWR 58211 P00	1-Form-C/BS		3	12	108	120	132			±1.6
HGWR 58211 L00	1-Form-C/BS		6	20	360	400	440			±3.1
HGWR 58211 H00	1-Form-C/BS		12	38	1215	1350	1485			±6.7
HGWR 58211 E00	1-Form-C/BS		24	70	4050	4500	4950			±14.4
HGWR 58212 N00	1-Form-C/BS/DC		9	19	306	340	374			±4.1
HGWR 58212 P00	1-Form-C/BS/DC		12	26	585	650	715			±5.9
HGWR 58212 T00	1-Form-C/BS/DC		24	40	1350	1500	1650			±10.4
HGWM 51111 K00	1-Form-C/SSS		5	11	105.3	117	128.7			2.9
HGWM 51111 P00	1-Form-C/SSS		12	27	648	720	792			7
HGWM 51111 T00	1-Form-C/SSS		24	52	2457	2730	3003			14
HGWM 51111 W00	1-Form-C/SSS		48	100	9000	10000	11000			28
HGW2MT 54111 G00	2-Form-C/SSS		5	11	50.4	56	61.6			2.9
HGW2MT 54111 L00	2-Form-C/SSS		12	28	352.8	392	431.2			7
HGW2MT 54111 P00	2-Form-C/SSS		24	54	1296	1440	1584			14
HGRM 51111/55211 J00	1-Form-C/SSS		5	11	63	70	77			1.8
HGRM 51111/55211 N00	1-Form-C/SSS		12	28	391.5	435	478.5			4.6
HGRM 51111/55211 R00	1-Form-C/SSS		24	55	1575	1750	1925			8.8
HGRM 51111/55211 V00	1-Form-C/SSS		48	103	5490	6100	6710			17
HGR2MT 51111 F00	2-Form-C/SSS		5	11	33.3	37	40.7			2
HGR2MT 51111 K00	2-Form-C/SSS		12	30	225	250	275			5
HGR2MT 51111 N00	2-Form-C/SSS		24	56	783	870	957			10
HGR2M 53211 H00	2-Form-C/SSS		5	16	108	120	132			2.65
HGR2M 53211 M00	2-Form-C/SSS		12	42	702	780	858			6.65
HGR2M 53211 Q00	2-Form-C/SSS		24	81	2610	2900	3190			12.2
HGR2M 53211 T00	2-Form-C/SSS		48	164	10800	12000	13200			26.5
HGSR 51211 J00	1-Form-C/SSS		5	11	63	70	77			1.8
HGSR 51211 N00	1-Form-C/SSS		12	28	391.5	435	478.5			4.6
HGSR 51211 R00	1-Form-C/SSS		24	55	1575	1750	1925			8.8
HGSR 51211 V00	1-Form-C/SSS		48	103	5490	6100	6710			17
HGSM 51111 IC0	1-Form-C/SSS		5	22	302	335	369			3.5
HGSM 51111 K00	1-Form-C/SSS		5	16	126	140	154			2.3
HGSM 51111 P00	1-Form-C/SSS		12	41	846	940	1034			6
HGSM 51111 T00	1-Form-C/SSS		24	80	3258	3620	3982			12
HGSM 51111 V00	1-Form-C/SSS		48	122	7740	8600	9460			19
HG 11331 G00	1-Form-D/SSS		5	8.3	31.5	35	38.5			3.4
HG 11331 K00	1-Form-D/SSS		12	16.5	126	140	154			7.1
HG 11331 N00	1-Form-D/SSS		24	34	522	580	638			14
HG 11331 R00	1-Form-D/SSS		48	65	1935	2150	2365			28
HGM 11411 H00	1-Form-D/SSS		5	6.4	18.63	20.7	22.77			2.84
HGM 11411 M00	1-Form-D/SSS		12	16	115.2	128	140.8			7.2
HGM 11411 Q00	1-Form-D/SSS		24	31	450	500	550			14.9
HGM 11411 T00	1-Form-D/SSS		48	66	1953	2170	2387			29.8
HGPM 11441 M00	1-Form-D/SSS		5	16	115.2	128	140.8			2.75
HGPM 11441 R00	1-Form-D/SSS		12	39	703.8	782	860.2			6.7
HGPM 11441 U00	1-Form-D/SSS		24	79	2862	3180	3498			13.8
HGPM 11441 X00	1-Form-D/SSS		48	156	10980	12200	13420			27

SSS: Single Side Stable Relay

BS: Bistable Relay

DC: Double Coil

USA 1-877-4REMTECH Europe 32-11-300868 Japan 81-3-3667-3302 Ext. 2419

HongKong/China/Korea 852-2880-6773 Taiwan 886-2-2726-2177 Singapore/Far East 65-296-3388

## HG SERIES REED RELAYS

HGRM • HGR2M • HGR2MT • HGSR • HGSM • HGJM • HGJ2MT  
HGWR • HGWM • HGW2MT • HG • HGM

### COIL SPECIFICATIONS

Units	Release Voltage			Nominal Input Power			Options
	Volts			mW			
Conditions	Must release by 25°						
Part #	Min	Typ	Max	Min	Typ	Max	
HGJM 51111 K00	0.61				200		Electrostatic Shield Bistable Latching IR: 10 <sup>11</sup>
HGJM 51111 P00	1.5				210		
HGJM 51111 T00	3				217		
HGJM 51111 W00	6				234		
HGJ2MT 54211 G00	0.55				455		IR: 10 <sup>11</sup>
HGJ2MT 54211 L00	1.4				389		
HGJ2MT 54211 P00	2.7				420		
HGWR 56211 H00	0.17				346		Form-D Contacts
HGWR 56211 L00	0.38				277		
HGWR 56211 P00	0.65				360		
HGWR 56211 T00	1.46				427		
HGWR 56211 W00	3.2				512		
HGWR 58211 T00	±0.25				80		Form-D Contacts
HGWR 58211 P00	±0.56				75		
HGWR 58211 L00	±1.1				90		
HGWR 58211 H00	±2.2				107		
HGWR 58211 E00	±4.9				128		
HGWR 58212 N00	±1.3				238		
HGWR 58212 P00	±1.9				222		
HGWR 58212 T00	±3.4				384		
HGWM 51111 K00	0.52				214		Electrostatic Shield Bistable Latching Form-D Contacts IR: 10 <sup>11</sup>
HGWM 51111 P00	1.3				200		
HGWM 51111 T00	2.6				211		
HGWM 51111 W00	5.2				230		
HGW2MT 54111 G00	0.52				446		Electrostatic Shield Form-D Contacts IR: 10 <sup>11</sup>
HGW2MT 54111 L00	1.3				367		
HGW2MT 54111 P00	2.6				400		
HGRM 51111/55211 J00	0.44				357		Form-D Contacts
HGRM 51111/55211 N00	1.1				331		
HGRM 51111/55211 R00	2.2				329		
HGRM 51111/55211 V00	4.3				378		
HGR2MT 51111 F00	0.5				676		Electrostatic Shield Form-D Contacts
HGR2MT 51111 K00	1.95				576		
HGR2MT 51111 N00	2.5				662		
HGR2M 53211 H00	0.37				208		Bistable Latching
HGR2M 53211 M00	0.91				185		
HGR2M 53211 Q00	1.83				199		
HGR2M 53211 T00	3.67				192		
HGSR 51211 J00	0.35				357		Form-D Contacts
HGSR 51211 N00	0.94				331		
HGSR 51211 R00	1.7				329		
HGSR 51211 V00	3.5				378		
HGSM 51111 IC0	0.75				75		Form-D Contacts Bistable Latching Electrostatic Shield
HGSM 51111 K00	0.46				179		
HGSM 51111 P00	1.2				153		
HGSM 51111 T00	2.41				159		
HGSM 51111 V00	3.8				268		
HG 11331 G00	1.13				714		Double Wound Coil 50/100mW version Bistable Latching 2-Form-D
HG 11331 K00	2.3				1029		
HG 11331 N00	4.7				993		
HG 11331 R00	9.1				1072		
HGM 11411 H00	0.91				1208		Double Wound Coil Bistable Latching
HGM 11411 M00	2.13				1125		
HGM 11411 Q00	4.05				1152		
HGM 11411 T00	8.79				1062		
HGPM 11441 M00	0.16				195		Double Wound Coil Bistable Latching
HGPM 11441 R00	0.4				184		
HGPM 11441 U00	0.8				181		
HGPM 11441 X00	1.6				189		

# HG SERIES REED RELAYS

HGRM • HGR2M • HGR2MT • HGSR • HGSM • HGJM • HGJ2MT  
 HGWR • HGWM • HGW2MT • HG • HGM

## MECHANICAL DIMENSIONS

DIMENSIONS  
 mm  
 (Inches)

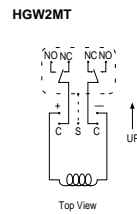
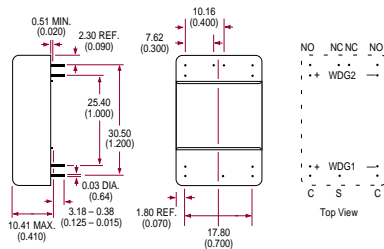
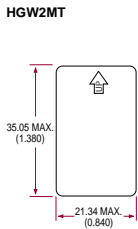
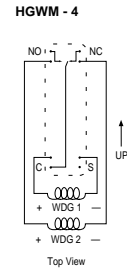
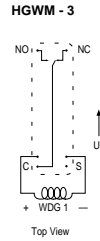
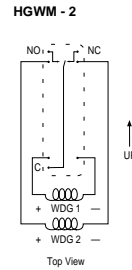
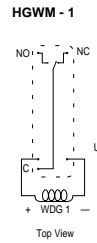
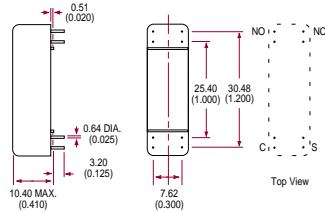
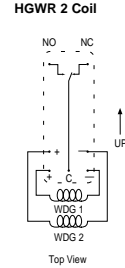
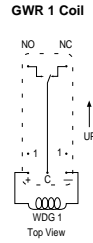
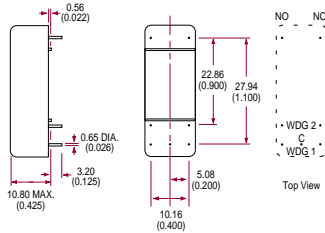
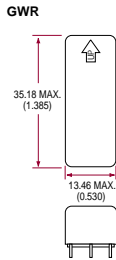

# HG SERIES REED RELAYS

HGRM • HGR2M • HGR2MT • HGSR • HGSM • HGJM • HGJ2MT  
 HGWR • HGWM • HGW2MT • HG • HGM

## MECHANICAL DIMENSIONS

DIMENSIONS  
 mm  
 (inches)

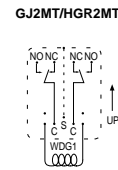
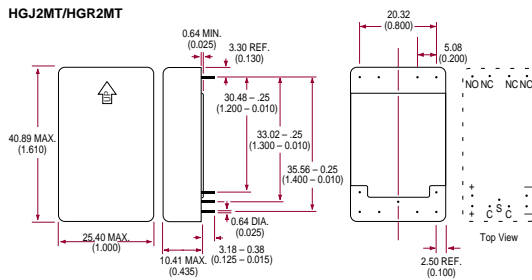
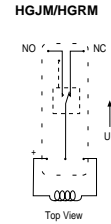
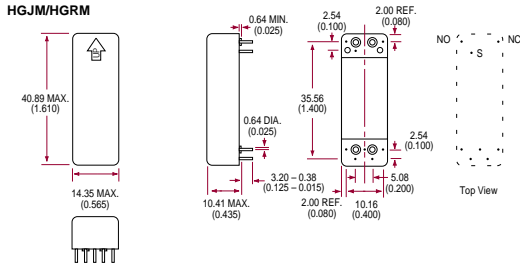
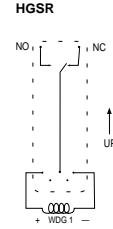
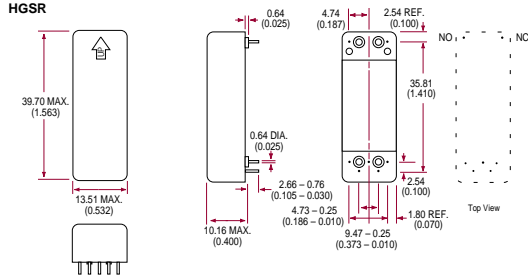



# HG SERIES REED RELAYS

HGRM • HGR2M • HGR2MT • HGSR • HGSM • HGJM • HGJ2MT  
 HGWR • HGWM • HGW2MT • HG • HGM

## MECHANICAL DIMENSIONS

DIMENSIONS  
 mm  
 (inches)

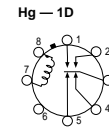
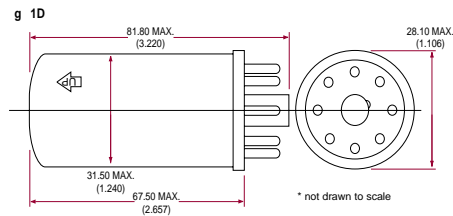
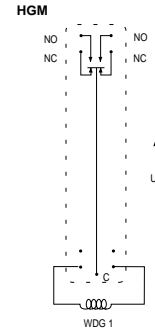
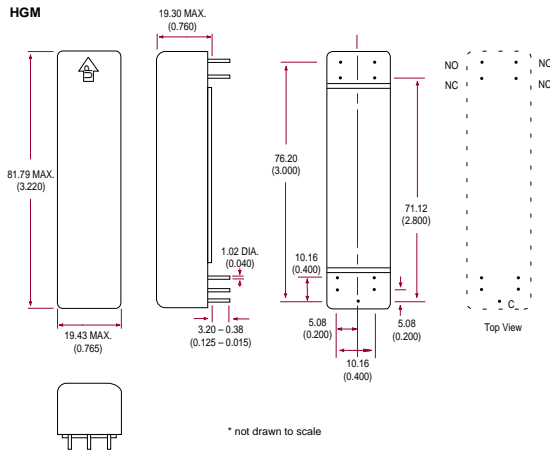
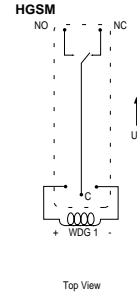
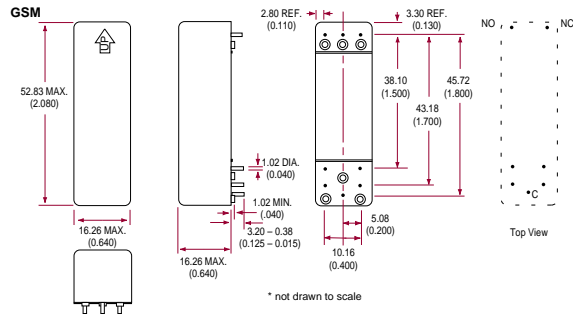

USA 1-877-4REMTECH Europe 32-11-300868 Japan 81-3-3667-3302 Ext. 2419  
 HongKong/China/Korea 852-2880-6773 Taiwan 886-2-2726-2177 Singapore/Far East 65-296-3388

## HG SERIES REED RELAYS

HGRM • HGR2M • HGR2MT • HGSR • HGSM • HGJM • HGJ2MT  
HGWR • HGWM • HGW2MT • HG • HGM

### ORDERING INFORMATION

#### HGWM, HGW2MT, HGRM, HGJM, HGR2MT, HGJ2MT, RELAYS

A complete part number is represented by the digits below.

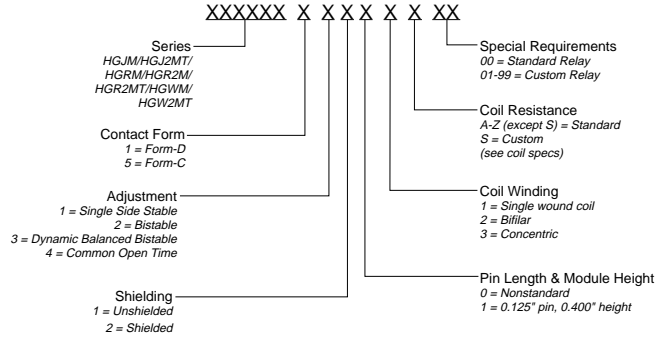

#### HGSR RELAYS

A complete part number is represented by the digits below.

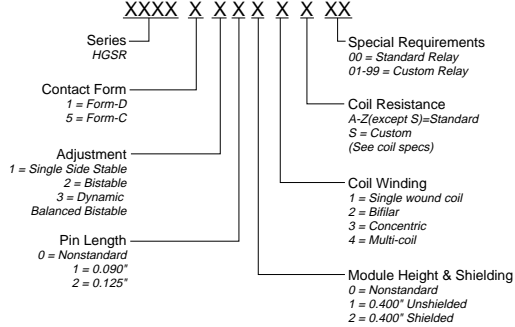

#### HGSM RELAYS

A complete part number is represented by the digits below.

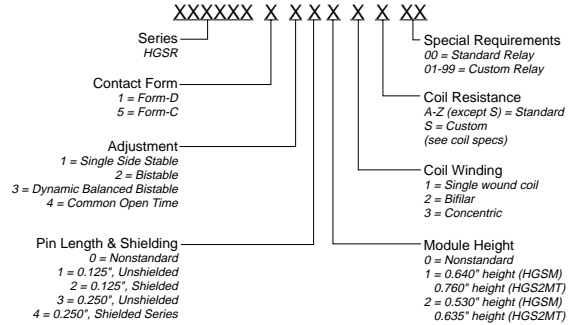

#### HGWR, HG, HGM, RELAYS

A complete part number is given in the coil specifications chart.